



Simons  Voss



GatewayNode 2

Manual

02.03.2022

Simons  Voss
technologies

Contents

1	General	3
2	General safety instructions.....	4
3	Product-specific safety instructions.....	7
4	Meaning of the text formatting	8
5	Scope of delivery	9
5.1	Accessories	9
6	Connections.....	10
7	Installation	11
7.1	Antenna	13
8	Initial operation.....	16
8.1	IPsettings.....	16
9	Browser interface.....	17
10	Maintenance.....	21
11	Signalling	22
12	Fault rectification.....	23
12.1	Reset	23
13	Technical specifications	25
13.1	Optional external antenna	27
13.1.1	Electrical specifications	27
13.1.2	Connection specifications.....	27
13.1.3	Mechanical specifications and dimensions	28
14	EU/UK Declaration of conformity.....	29
15	Help and other information	30

1 General

2 General safety instructions

Signal word (ANSI Z535.6)	Possible immediate effects of non-compliance
DANGER	Death or serious injury (likely)
WARNING	Death or serious injury (possible, but unlikely)
CAUTION	Minor injury
IMPORTANT	Property damage or malfunction
NOTE	Low or none



WARNING

Blocked access

Access through a door may stay blocked due to incorrectly fitted and/or incorrectly programmed components. SimonsVoss Technologies GmbH is not liable for the consequences of blocked access such as access to injured or endangered persons, material damage or other damage!

Blocked access through manipulation of the product

If you change the product on your own, malfunctions can occur and access through a door can be blocked.

- ❑ Modify the product only when needed and only in the manner described in the documentation.

IMPORTANT

Damage resulting from electrostatic discharge (ESD)

This product contains electronic components that may be damaged by electrostatic discharges.

1. Use ESD-compliant working materials (e.g. Grounding strap).
2. Ground yourself before carrying out any work that could bring you into contact with the electronics. For this purpose, touch earthed metallic surfaces (e.g. door frames, water pipes or heating valves).

Damage resulting from liquids

This product contains electronic components that may be damaged by liquids of any kind.

- ❑ Keep liquids away from the electronics.

Damage resulting from aggressive cleaning agents

The surface of this product may be damaged as a result of the use of unsuitable cleaning agents.

- ❑ Only use cleaning agents that are suitable for plastic or metal surfaces.

Damage as a result of mechanical impact

This product contains electronic components that may be damaged by mechanical impacts of any kind.

1. Avoid touching the electronics.
2. Avoid other mechanical influences on the electronics.

Damage as a result of overcurrent or overvoltage

This product contains electronic components that may be damaged by excessive current or voltage.

- ❑ Do not exceed the maximum permissible voltages and/or currents.

Damage due to polarity reversal

This product contains electronic components that may be damaged by reverse polarity of the power source.

- ❑ Do not reverse the polarity of the voltage source (batteries or mains adapters).

Operational malfunction due to radio interference

This product may be affected by electromagnetic or magnetic interference.

- ❑ Do not mount or place the product directly next to devices that could cause electromagnetic or magnetic interference (switching power supplies!).

Communication interference due to metallic surfaces

This product communicates wirelessly. Metallic surfaces can greatly reduce the range of the product.

- ❑ Do not mount or place the product on or near metallic surfaces.



NOTE

Intended use

SmartIntego-products are designed exclusively for opening and closing doors and similar objects.

- ❑ Do not use SmartIntego products for any other purposes.

Qualifications required

The installation and commissioning requires specialized knowledge.

- ❑ Only trained personnel may install and commission the product.

Incorrect installation

SimonsVoss Technologies GmbH accepts no liability for damage caused to doors or components due to incorrect fitting or installation.

Modifications or further technical developments cannot be excluded and may be implemented without notice.

The German language version is the original instruction manual. Other languages (drafting in the contract language) are translations of the original instructions.

Read and follow all installation, installation, and commissioning instructions. Pass these instructions and any maintenance instructions to the user.

3 Product-specific safety instructions



CAUTION

Risk of burns due to hot circuit board

If you power the device with Power-over-Ethernet (PoE), the board can become very hot.

- Allow the unit to cool down before opening the housing.

Risk of electric shock from connected power supply

The device is supplied with power during operation. Opening the housing and touching live parts may result in electric shock.

1. If the power supply is connected, do not open the housing.
2. Disconnect the power supply (or disconnect the network cable) before opening the housing.



NOTE

Unauthorised access with standard access data

The standard access data can be viewed freely. Unauthorised persons cannot change the access authorisations, but they can change the network configuration. You will then no longer be able to reach the device via the network and will have to reset it.

Some browsers do not transmit spaces at the beginning of the password.

1. Change the default password.
2. Do not start or end the password with spaces.

Further documentation

You can find further documentation about SmartIntego products on the SmartIntego page (www.smartintego.com).

4 Meaning of the text formatting

This documentation uses text formatting and design elements to facilitate understanding. The table explains the meaning of possible text formatting:

Example	button
<input checked="" type="checkbox"/> Example <input type="checkbox"/> Example	checkbox
<input checked="" type="radio"/> Example	Option
[Example]	Tab
"Example"	Name of a displayed window
Example	Upper programme bar
Example	Entry in the expanded upper programme bar
Example	Context menu entry
▼ Example	Name of a drop-down menu
"Example"	Selection option in a drop-down menu
"Example"	Area
Example	Field
<i>Example</i>	Name of a (Windows) service
<i>Example</i>	Commands (e.g. Windows CMD commands)
Example	Database entry
[Example]	MobileKey type selection

5 Scope of delivery

- GatewayNode 2: Cover, base plate with circuit board and three pre-assembled strain reliefs
- Removable sticker with Chip-ID
- Quick guide

5.1 Accessories

You can use optionally available accessories to adapt your device to different applications.

Order code	Name	Purpose
ANTENNA.EXT.868	External antennas	You can connect the external antenna to the MCX connector of the circuit board and improve reception (see Antenna [▶ 13]).
POWER.SUPPLY.2	Power supply (12 V _{DC} , 500 mA)	You can use this power supply unit to power your device.

6 Connections

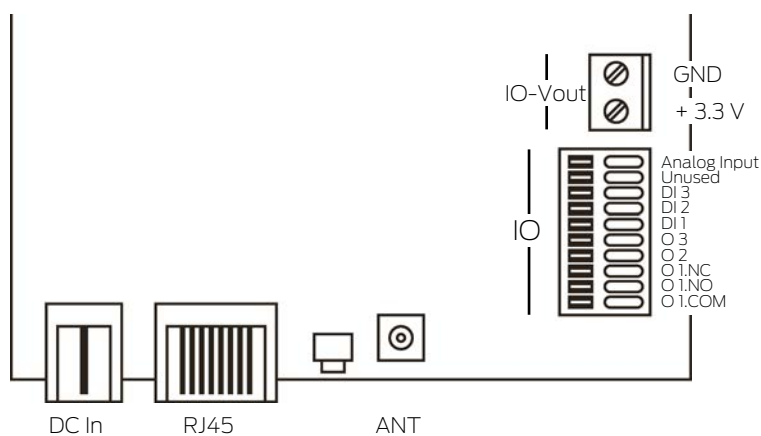

NOTE

IO connector only for RouterNode 2

You can only use the connectors of the IO connector at RouterNode 2.

Connection		Meaning
DC In	Pin connector	Power supply with round plug connector
IO-V _{out}	Terminal block: GND	Auxiliary voltage output - Earth connection
	Terminal block: +3.3 V	Auxiliary voltage output - Positive pole
RJ45		Network connection
ANT		Connector for external antenna (see <i>Antenna</i> [▶ 13])

7 Installation

The device can be fitted horizontally or vertically. You can fit it in a horizontal position easily and safely using the integrated mounting holes. Take into account the internal antenna's directional characteristic (see [Antenna \[▶ 13\]](#)) and align the device as appropriate.

IMPORTANT

Adverse effect on reception due to interferences

This device communicates wirelessly. Wireless communication can be affected or may fail due to metal surfaces or interference.

1. Do not fit the device to metal surfaces.
2. Keep the device away from sources of electrical or magnetic interference.

Unauthorised access

If the electrical contacts in the device are short-circuited by unauthorised persons, undesired reactions may occur.

- ❑ Mount the device in an environment that is protected from unauthorised access.

Malfunctions due to weather conditions

This device is not protected against splash water and other weather influences.

- ❑ Mount the device in an environment that is protected from the weather.

1. Push in the housing cover as shown and remove the cover.

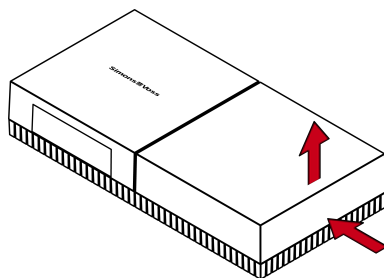

2. Hold the base plate in the required position and mark the drill holes.

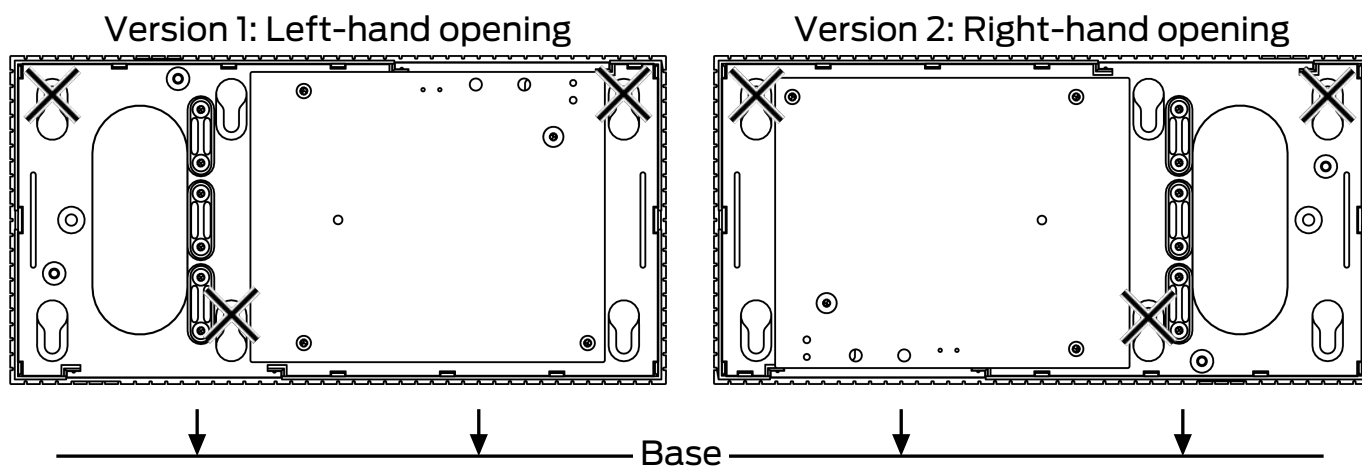

3. Drill the required holes with a suitable drill.
4. Use suitable dowels and fasten the screws for the base plate into position.
5. Place the base plate so that the screw heads are fed through the recesses.

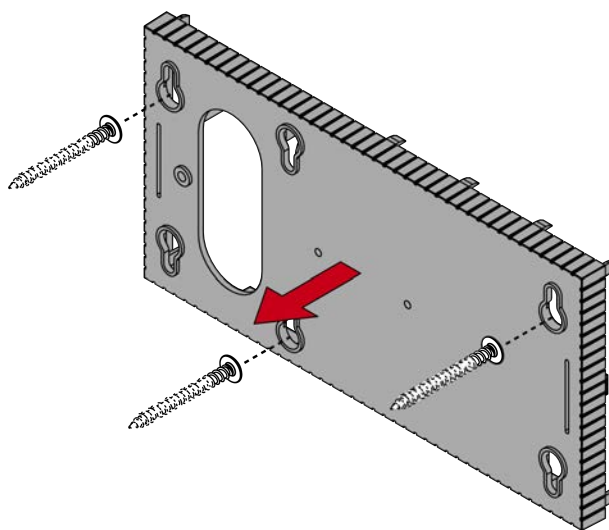

6. Slide the base plate so that the screw heads slide along the grooves.

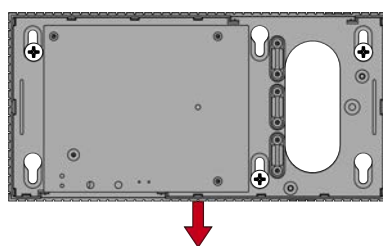

7. Place the cover on the base plate again.

↳ Installation completed.

Wiring to device

You can install the cables both on (surface-mounted) and under (flush-mounted) plaster.

- If you install the cables under the plaster, then use the opening integrated in the base plate.
- If you lay the cables on the plaster, then you must modify the housing.
- ✓ Power supply disconnected.

1. Push the ribbed area laterally inwards and remove the housing cover.

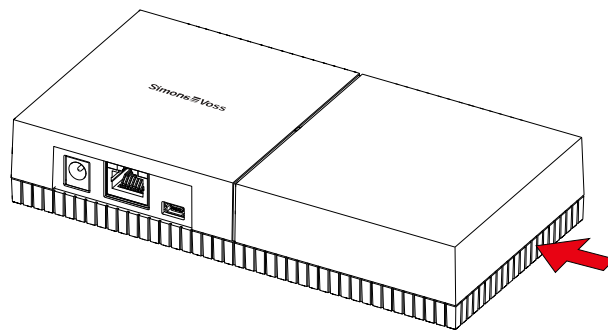

2. Check the required width of the housing opening. The height of the opening is approx. 7 mm. Each removed bar widens the opening by 4 mm.
3. Select a location where you want to remove the bars.

IMPORTANT

Insufficient fit due to removed clips

The housing cover is positioned and held by clips on the webs. If you saw off or break off these clips, the housing cover will no longer be held at this point.

1. Do not remove any bars that have a clip over them.
 2. Do not damage clips during sawing.
 4. Use a suitable saw to saw through the bars at both ends of the desired opening to the base plate.
 5. Bend the bars back and forth at the desired opening until the bars break.
- ↳ The housing is designed to be mounted on a surface.

7.1 Antenna

The internal antenna radiates as shown. The transmitting and receiving power is therefore different depending on the direction and is possibly influenced by the environment (sources of interference and/or metallic surfaces).

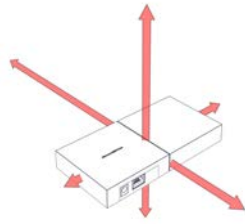

External antennas



Use the external antenna if any of the following problems occur.

- Transmission and reception behaviour not stable
- Range too short
- Transmission and reception outdoors (LockNodes available outdoors)

The external antenna is suitable for outdoor use. This allows you to place the device in the protected area while the antenna is outdoors.

The scope of delivery of the external antenna includes:

- Integrated magnetic base
- Wall mounting material
- Dowels and screws

You do not need to change any settings after connecting the external antenna. When the external antenna is connected, the device transmits via the internal and external antennas (the internal antenna is not disabled by connecting the external antenna).

- ✓ Power supply disconnected.

1. Open the housing.

2. Locate the connector socket on the circuit board.

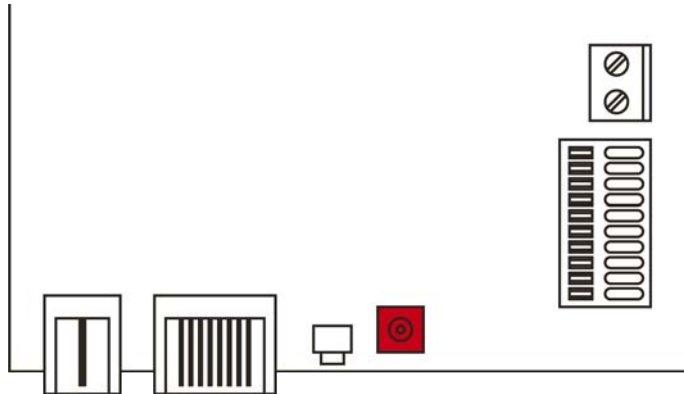

3. Connect the external antenna to the connector socket.
↳ The external antenna is connected.
4. Close the housing again.
↳ The device transmits via internal and external antenna.

8 Initial operation

1. Mount the device (see [Installation \[▶ 11\]](#)).
2. Supply the device with power.

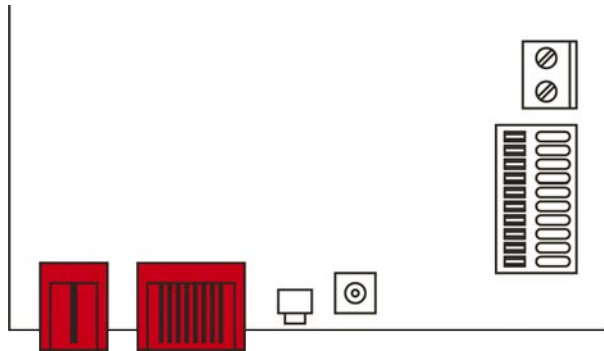

3. Connect the device to your network.
 4. Use the OAM-Tool to determine the IP address of your device in the network (see OAM-Tool manual).
 5. Connect the device to your system (see SmartIntego TechGuide).
- ↳ The device has been put into operation and is now flashing green slowly (see [Signalling \[▶ 22\]](#)).

8.1 IPsettings

Your device can be addressed via an IP address in the network. There are two ways to integrate your device into the network:

- Automatic assignment of an IP address by a DHCP server in the network: Unless you make other settings, an IP address is automatically assigned to your device by a DHCP server. You can change this IP address manually later. If you do not know the IP address, you can determine the IP address with the OAM tool.
- Manual assignment of an IP address: Assign the IP address manually.

You can change the IP settings in the SmartIntego Manager.

If you reset the network settings in your device (see [Reset \[▶ 23\]](#)), the default IP address will only be restored if you assign it manually. However, if the IP address was assigned by a DHCP server, the IP address will be reassigned by the DHCP server directly following reset.

9 Browser interface

You can use the Ethernet interface in the browser to configure the following for RouterNodes, GatewayNodes and SmartBridges:

- Allow changes using the OAM tool
- Password for the web interface
- IP address/DHCP mode
- Opening and closing the SMTP port

Launching

You receive the device with the following factory configuration:

IP address	192.168.100.100 (if no DHCP server is found)
Subnet mask	255.255.0.0
User name	SimonsVoss
Password	SimonsVoss

The procedure is described for RouterNodes. Use the same procedure for SmartIntego GatewayNodes and MobileKey SmartBridges.

Change the default password after you launch for the first time.

- ✓ RouterNode IP known (see Determining and setting the IP address).
- ✓ Browser open.
- ✓ User credentials known for the browser interface (name and password).

1. Enter the IP address in your browser's address field.

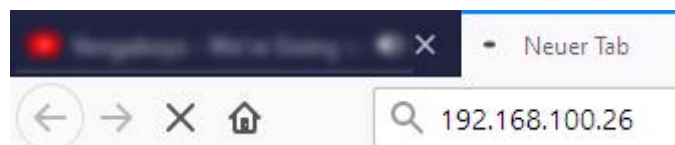

2. Press the Enter key to confirm.

↳ The "Authentication required" window will open.

A screenshot of an 'Authentication Required' dialog box. The dialog box has a title bar with 'Authentication Required' and a close button (X). Inside the dialog box, there is a question mark icon and the text 'http://192.168.100.29 is requesting your username and password. The site says: "protected area"'. Below this text are two input fields: 'User Name:' and 'Password:'. At the bottom of the dialog box are two buttons: 'OK' and 'Cancel'.

3. Enter the login credentials.

4. Click on the **OK** button.

↳ The browser interface system overview is visible.

OVERVIEW
WAVENET
CONNECTION

System Information: Overview

Version:

Firmware version: 40.11.00

Basic network settings:

MAC Address:	94:50:89:00:36:44
Host Name:	SV_003644
DHCP:	On
IP-Address:	192.168.100.26
Subnetmask:	255.255.255.0
Gateway:	192.168.100.1
DNS-Server1:	192.168.100.1
DNS-Server2:	0.0.0.0
SV Port:	2101
SV SecPort:	2153



NOTE

Web interface can no longer be used with the default password with firmware 40.12 and above

The browser interface remains blocked in firmware version 40.12 or above until the default password has been changed.

❏ Change the default password.

↳ Browser interface is unblocked and settings can be changed.



NOTE

Unauthorised access with standard access data

The standard access data can be viewed freely. Unauthorised persons cannot change the access authorisations, but they can change the network configuration. You will then no longer be able to reach the device via the network and will have to reset it.

Some browsers do not transmit spaces at the beginning of the password.

1. Change the default password.
2. Do not start or end the password with spaces.

Blocking/enable change to the IP address using the OAM tool

If you do not enable the ▼ OAM-Tool allow, you will not be able to use the OAM tool to perform updates.

- ✓ Browser interface opened.
- 1. Open the [PORT] tab using | CONFIGURATION |.
 - ↳ You will see an overview of the TCP port settings for RouterNode 2.

NETWORK
PORT
ETHERNET INTERFACE
WAVENET

Configuration: port settings

TCP port settings:

SV Port:	<input type="text" value="2101"/>
SV SecPort:	<input type="text" value="2153"/>
SV connection timeout [s]:	<input type="text" value="30"/>
HTTP:	<input type="text" value="On"/>
Telnet:	<input type="text" value="Off"/>
OAM-Tool allow:	<input type="text" value="Yes"/>

- 2. Select the option "Yes" (enable the OAM tool to change the IP) or the option "No" (block change to the IP by the OAM tool) from the ▼ OAM-Tool allow drop-down menu.
- 3. Click on the button .
 - ↳ Changing the IP address using the OAM tool is locked/allowed.

Change password

Some browsers do not register any spaces included at the start of a password, so do not begin your password with spaces.

- ✓ Browser interface opened.
- 1. Open the [PASSWORD] tab using | ADMINISTRATION |.

PAS SWORD
CERTIFICATE
FACTORY
REBOOT

Administration: Change password

New password:

New password:	<input type="text"/>
Confirm password:	<input type="text"/>

2. Enter your new password.
 3. Repeat your new password.
 4. Click on the **Save password** button.
- ↳ Password is now changed.

Opening and closing the SMTP port

The SMTP port is open ex works and after each reset. As a general rule, ports that are not required should be closed. If you close the SMTP port, the OAM tool will no longer find RouterNode 2.

- ✓ Browser interface opened.
1. Open the [PORT] tab using | CONFIGURATION |.
- ↳ You will see an overview of the TCP port settings for RouterNode 2.

NETWORK
PORT
ETHERNET INTERFACE
WAVENET

Configuration: port settings

TCP port settings:

SV Port:	<input type="text" value="2101"/>
SV SecPort:	<input type="text" value="2153"/>
SV connection timeout [s]:	<input type="text" value="30"/>
HTTP:	<input type="text" value="On"/> ▾
Telnet:	<input type="text" value="Off"/> ▾
OAM-Tool allow:	<input type="text" value="Yes"/> ▾

2. Select the "Yes" option (open SMTP port) or the "No" option (close SMTP port) from the ▼ SMTP Port drop-down menu.
 3. Click on the button **Save**.
- ↳ The SMTP port is open or closed.

10 Maintenance

The device itself is maintenance-free. However, the performance of radio networks will always depend on environmental influences. These influences can change and affect the performance of your radio network. You should therefore check the network configuration and performance of your radio network at regular intervals.



CAUTION

Network failure in critical situations

With the System 3060 and WaveNet you can implement emergency functions such as amok protection. These emergency functions are critical.

1. Test locking systems in which critical emergency functions are implemented at least once a month.
2. If necessary, also comply with other standards and regulations according to which your system is operated.

11 Signalling

Signal	Meaning
Green flashing (~1.5 Hz)	Configured and ready to use.
Green flashing (~0.3 Hz)	Not configured, but ready for operation
Red flashing (briefly)	Restart
Green flickering	Data transfer

12 Fault rectification

If problems occur during operation, you may be able to rectify them yourself:

1. Check the power supply of the affected devices.
2. Check the network connection.
3. Check the authorisations assigned.

12.1 Reset

If problems should occur or you want to reset the device to its initial state, you can reset the device with the reset button.

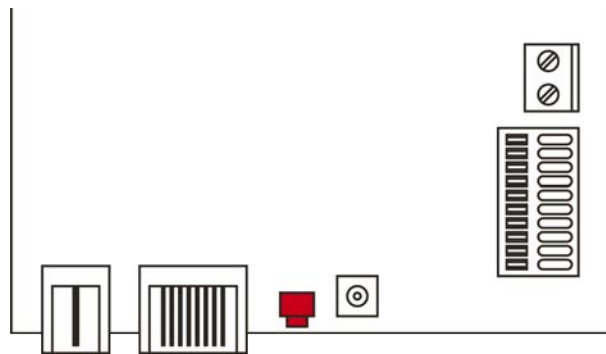

Make a distinction between them:

- Reset SmartIntego configuration: Reset all SmartIntego settings.
- Reset network configuration: Reset all network settings (IP address, DHCP settings, host name).



NOTE

IP address recovery

If the IP address is assigned by a DHCP server (default setting), the DHCP server assigns the IP address again directly after resetting (depending on settings of the DHCP server).

Reset the SmartIntego configuration

1. Disconnect the power supply (round plug or network cable for PoE).
2. Wait 20 seconds.
3. Press and hold the reset button.
4. Reconnect the power supply (round plug or network cable for PoE).
5. Release the reset button after one second.
 - ↳ Device flashes green again (see *Signalling* [▶ 22]).
 - ↳ SmartIntego configuration is reset.

Reset network configuration

1. Disconnect the power supply (round plug or network cable for PoE).
2. Wait 20 seconds.
3. Press and hold the reset button.
4. Reconnect the power supply (round plug or network cable for PoE).
5. Release the reset button after five seconds.
 - ↳ Device flashes green again (see *Signalling* [▶ 22]).
 - ↳ Network configuration is reset.



NOTE

Unauthorised access with standard access data

The standard access data can be viewed freely. Unauthorised persons cannot change the access authorisations, but they can change the network configuration. You will then no longer be able to reach the device via the network and will have to reset it.

Some browsers do not transmit spaces at the beginning of the password.

1. Change the default password.
2. Do not start or end the password with spaces.

You receive the device with the following factory configuration:

IPAddress	192,168,100,100
User name	SimonsVoss
Password	SimonsVoss

The IP address of your device on your network can be determined using the free OAM tool (<https://www.simons-voss.com/de/downloads/software-downloads.html>). Please refer to the manual for more information.

13 Technical specifications

General	
Dimensions	172 mm × 86 mm × 33 mm
Weight	About 100 g
Material	ABS plastic, UV-stable
Colour	White (like RAL 9016 "Traffic white")
Installation	<ul style="list-style-type: none"> ■ horizontal ■ vertical ■ Wall mounting possible ■ Integrated strain relief (3x)
Connections	<ul style="list-style-type: none"> ■ RJ45 (Network/PoE) ■ Round plug Ø 5.5 mm, Ø pin 2.0 mm (power supply) ■ Screw terminal block 2-pole, wire diameter 0.14 mm² to 1.5 mm² (power supply for external applications) ■ MCX socket (optional external antenna) <p>Power supply via PoE and round plug possible simultaneously: round plug > 12 V_{DC} → Round plug used, round plug < 12 V_{DC} → PoE used</p>
Environment	
Temperature	<ul style="list-style-type: none"> ■ Operational: -10 °C to +55 °C ■ Storage: -20 °C to +60 °C
Humidity	Max. 90%, non-condensing
Standard protection rating	IP20
Electric	
Operating voltage	<p>9 V_{DC} to 32 V_{DC} (reverse polarity protected) or PoE according to IEEE 802.3af</p> <p>Power supply via PoE and round plug possible simultaneously: round plug > 12 V_{DC} → Round plug used, round plug < 12 V_{DC} → PoE used</p>
Output	max. 3 W

Output VOUT	3.0 V _{DC} to 3.3 V _{DC} , max. 200 mA
Relay output O1	<ul style="list-style-type: none"> ■ Max. switching voltage 30 V_{DC}/24V_{AC} (resistive load) ■ Max. switching current 1 A (resistive load)
Interfaces	
RJ45	<ul style="list-style-type: none"> ■ Network interface ■ 10T/100T ■ HP Auto_MDX ■ DHCP-Client (DHCP: on) ■ IPv4 ■ Service <ul style="list-style-type: none"> ■ TCP: 1x at Port 2101 ■ UDP: 1x for Digi-Scan (OAM tool) ■ Web server: Enable
868 MHz radio	WaveNet interface, range up to 30 m
Analogue input	1x with 12-bit resolution from 0 to 3.3 V _{DC}
Relay contacts	1x change-over contact, potential-free.
Signalling	
LED	RGB LED (centre of housing)
Software	
Programming	via TCP/IP interface

Radio emissions		
SRD (WaveNet)	868.000 MHz - 868.600 MHz	<25 mW ERP

There are no geographical restrictions within the EU.

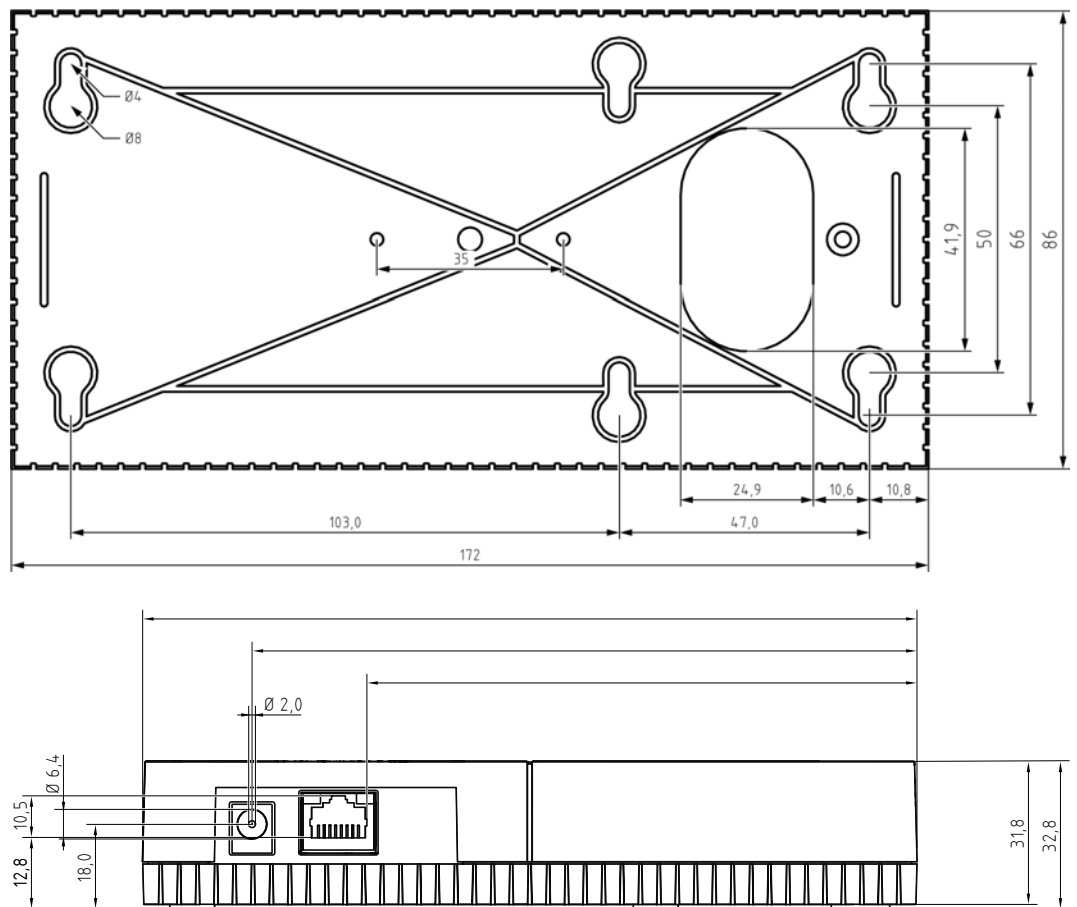

13.1 Optional external antenna

13.1.1 Electrical specifications

Type	Multiband antenna
Frequencies	<ul style="list-style-type: none"> ■ AMPS (824 - 894MHz) ■ GSM (900MHz) ■ DCS (1800MHz) ■ PCS (1900MHz) 3G (UMTS 2,1GHz)
Impedance	50 Ω
Polarization	Linear
Gain	2,2dBi max.
VSWR	< 3:1
Operating temperature	-40°C to +85°C

13.1.2 Connection specifications

Connector type	MCX male
----------------	----------

Cable	RG174U
Cable length	250cm

13.1.3 Mechanical specifications and dimensions

Mounting	Magnetic Mount
Material	ABS
Max. dimensions	30,9mm x 71,5mm (Ø x H)
Weight	50g 'weight with connection above'
Colour	Black

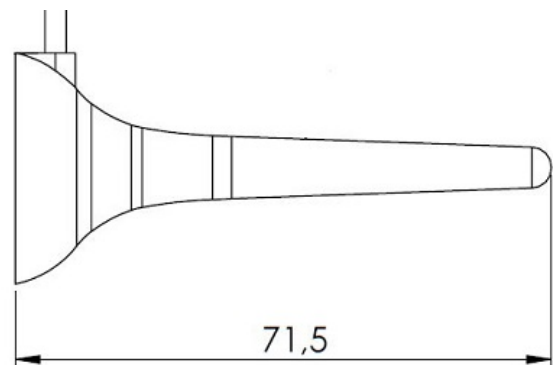
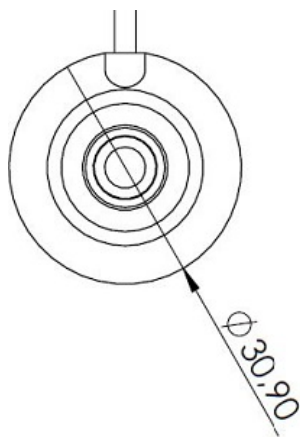

14 EU/UK Declaration of conformity

The company SimonsVoss Technologies GmbH hereby declares that article MK.SMARTBRIDGE.ER/WNM.RN2.ER.IO/WN.RN2.ER/SI.GN2.ER(.M) complies with the following guidelines:

- 2014/53/EU "Radio equipment"
as well as the corresponding UK statutory 2017 No. 1206 "Radio equipment"
- 2014/30/EU "EMC"
as well as the corresponding UK statutory 2016 No. 1091 "EMC"
- 2012/19/EU "WEEE"
as well as the corresponding UK statutory 2013/3113 "WEEE"
- 2011/65/EU "RoHS"
as well as the corresponding UK statutory 2012 No. 3032 "RoHS"
- and regulation (EG) 1907/2006 "EU REACH"
as well as the corresponding "UK REACH"

The full text of the EU/UK Declaration of conformity is available at the following internet address:

<https://www.simons-voss.com/en/certificates.html>



15 Help and other information

Information material/documents

You will find detailed information on operation and configuration and other documents on the website:

<https://www.smartintego.com/int/home/infocenter/documentation>

Software and drivers

Software and drivers can be found on the website:

<https://www.simons-voss.com/en/service/software-downloads.html>

Declarations of conformity

You will find declarations of conformity and other certificates on the website:

<https://www.simons-voss.com/en/certificates.html>

Information on disposal

- Do not dispose the device (MK.SMARTBRIDGE.ER/WNM.RN2.ER.IO/WN.RN2.ER/SI.GN2.ER(.M)) in the household waste. Dispose of it at a collection point for electronic waste as per European Directive 2012/19/EU.
- Take the packaging to an environmentally responsible recycling point.



Hotline

Our hotline will be happy to help you (landline, costs depend on provider):

+49 (0) 89 / 99 228 333

Email

You may prefer to send us an email.

si-support-simonsvoss@allegion.com

FAQs

You will find information and help in the FAQ section:

<https://faq.simons-voss.com/otrs/public.pl>

Address

SimonsVoss Technologies GmbH
Feringastr. 4
D-85774 Unterfoehring
Germany



This is SimonsVoss

SimonsVoss, the pioneer in remote-controlled, cable-free locking technology provides system solutions with a wide range of products for SOHOs, SMEs, major companies and public institutions. SimonsVoss locking systems combine intelligent functionality, high quality and award-winning design Made in Germany.

As an innovative system provider, SimonsVoss focuses on scalable systems, high security, reliable components, powerful software and simple operation. As such, SimonsVoss is regarded as a technology leader in digital locking systems.

Our commercial success lies in the courage to innovate, sustainable thinking and action, and heartfelt appreciation of employees and partners.

SimonsVoss is a company in the ALLEGION Group, a globally active network in the security sector. Allegion is represented in around 130 countries worldwide (www.allegion.com).

Made in Germany

SimonsVoss is truly committed to Germany as a manufacturing location: all products are developed and produced exclusively in Germany.

© 2022, SimonsVoss Technologies GmbH, Unterföhring

All rights are reserved. Text, images and diagrams are protected under copyright law.

The content of this document must not be copied, distributed or modified. More information about this product can be found on the SimonsVoss website. Subject to technical changes.

SimonsVoss and MobileKey are registered brands belonging to SimonsVoss Technologies GmbH.



SimonsVoss
technologies

Made in Germany